

USB-1608G Series

16-Bit Multifunction DAQ Devices

Features

- 16-bit high-speed USB devices
- Acquisition rates up to 500 kS/s
- 8 differential (DIFF) or 16 single-ended (SE) analog inputs
- Two 16-bit analog outputs (USB-1608GX-2AO standard/OEM only)
- Eight individually-configurable digital I/O lines
- Two 32-bit counter inputs
- One timer output
- Available with enclosure and screw terminals, or as a board-only OEM version with header connectors (no case, CD, or USB cable included)



All USB-1608G Series devices offer 16 single-ended or eight differential analog inputs, 8 digital I/O, and one counter input. The USB-1608GX-2AO (shown here) also offers two analog outputs.

Software

Supported Operating Systems

- Windows 8/7/Vista®/XP 32/64-bit
 - Universal library (UL), ULx for NI LabVIEW™
- Linux® open-source driver support
- Android™
 - UL for Android

Ready-to-Run Applications

- InstaCal™ (install, configure, and test)
- DAQami™ Advanced Data Logging Application (acquire, view, and log)
- TracerDAQ® (acquire, view, log, and generate)

Supported Programming Environments

- Visual Studio® and Visual Studio .NET, including examples for Visual C++®, Visual C#®, Visual Basic®, and Visual Basic .NET, and other IDEs
- Java® (Android only) including examples and demo apps
- LabVIEW (Windows only)
- DASyLab®
- MATLAB® (Data Acquisition Toolbox™)

Overview

USB-1608G Series devices are low-cost, high-speed, analog and digital I/O USB devices. All of these devices offer up to eight DIFF or 16 SE analog inputs, eight digital I/O channels, two counter inputs, and one timer output.

USB-1608G Series Selection Chart					
Model	Analog Inputs	Sample Rate (max)	Analog Outputs	Signal I/O	USB Cable and SW CD
USB-1608G	16 SE/8 DIFF	250 kS/s	0	Screw Terminal	✓
USB-1608GX	16 SE/8 DIFF	500 kS/s	0	Screw Terminal	✓
USB-1608GX-2AO	16 SE/8 DIFF	500 kS/s	2	Screw Terminal	✓
USB-1608G-OEM	16 SE/8 DIFF	250 kS/s	0	Header	–
USB-1608GX-OEM	16 SE/8 DIFF	500 kS/s	0	Header	–
USB-1608GX-2AO-OEM	16 SE/8 DIFF	500 kS/s	2	Header	–

The USB-1608GX-2AO standard and OEM version offers two, 16-bit analog output channels with DAC rates up to 500 kS/s.

Analog Input

USB-1608G Series devices provide 16-bit analog inputs that are software-selectable as eight DIFF or 16 SE inputs. These devices also support input ranges of ± 10 V, ± 5 V, ± 2 V, and ± 1 V that are software-selectable per channel.

Analog Output (USB-1608GX-2AO only)

The USB-1608GX-2AO standard/OEM board has two 16-bit analog outputs that can be updated at a rate of 250 kS/s per channel; one output can be updated at a rate of 500 kS/s. The output range is fixed at ± 10 V.

Trigger Input

USB-1608G Series devices have an external digital trigger input. The trigger mode is software-selectable for edge- or level-sensitive mode. You can configure edge-sensitive mode for either rising or falling edge. In level-sensitive mode, you can configure for either high or low level. The default setting at power up is edge-sensitive, rising edge.

Retrigger Mode

In retrigger mode, you can set up repetitive analog input trigger events. The trigger is automatically re-armed after it is activated. Use software to set the A/D trigger count (the number of samples you want per trigger).

USB-1608G Series

General Information

USB-1608G Series Block Diagram

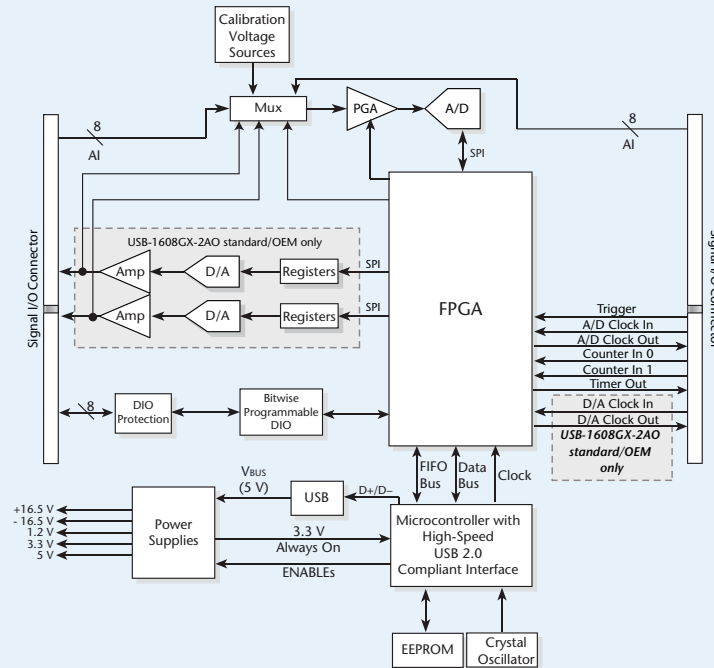

Digital I/O

Eight bidirectional digital I/O connections are individually configurable for input or output. The digital I/O terminals can detect the state of any TTL-level input. You can configure for pull-up (+5 V) or pull-down (0 V) with an onboard jumper.

Counter Input

Two 32-bit event counters are provided to count TTL pulses. The counters accept inputs of up to 20 MHz.

Timer Output

The PWM timer output generates a pulse output with a programmable frequency in the range of 0.0149 Hz to 32 MHz. The timer output parameters are software-selectable.

Clock Output

The AI clock pin outputs the signal from the internal clock.

Calibration

USB-1608G Series devices support field calibration. Run the InstaCal utility to calibrate the device whenever the ambient temperature changes by more than ± 10 °C from the last field calibration. Calibrate the inputs before calibrating the outputs.

USB-1608G Series devices are factory-calibrated. Specifications are guaranteed for one year. For calibration beyond one year, return the device to the factory for recalibration.

USB-1608G Series OEM Versions

OEM versions have board-only form factors with header connectors for OEM and embedded applications (no case, CD, or USB cable included). All devices can be further customized to meet customer needs.



The OEM versions have the same specifications as the standard devices, but come in a board-only form factor with header connectors instead of screw terminals.







USB-1608G Series

Software Support

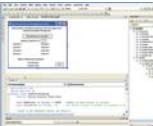

Software Support

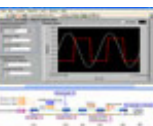
USB-1608G Series devices are supported by the software in the table below.

Ready-to-Run Applications		
InstaCal		An interactive utility that configures MCC hardware, and for supported devices, performs calibration tasks. Windows® OS InstaCal is included with the free MCC DAQ Software bundle (CD/download).
DAQami		Advanced data logging application with drag-and-drop software interface that is used to acquire, view, and log data. DAQami can be configured to log analog channels and to view that data in real-time or post-acquisition on user-configurable displays. Windows OS DAQami is available as a purchased software download.
TracerDAQ and TracerDAQ Pro		A virtual strip chart, oscilloscope, function generator, and rate generator applications used to generate, acquire, analyze, display, and export data. The Pro version provides enhanced features. Windows OS TracerDAQ is included with the free MCC DAQ Software bundle (CD/download). TracerDAQ Pro is available as a purchased software download.
General-Purpose Programming Support		
Universal Library (UL)		Programming library of function calls for C, C++, VB, C# .Net, and VB .Net using Visual Studio and other IDEs. Windows OS The UL is included with the free MCC DAQ Software bundle (CD/download).
UL for Android		Programming library of function calls for Java programmers who develop apps for Android-based tablets and phones. UL for Android communicates with select MCC DAQ devices. Supports Android project development on Windows, Linux, Mac OS X UL for Android is included with the free MCC DAQ Software bundle (CD/download).
Linux Driver		Open-source Linux drivers are available for most MCC devices. Example programs are also provided.
Application-Specific Programming Support		
ULx for NI LabVIEW		A comprehensive library of VIs and example programs for NI LabVIEW that is used to develop custom applications that interact with most MCC devices. Windows OS ULx is included with the free MCC DAQ Software bundle (CD/download).
DASYLab Driver		Icon-based data acquisition, graphics, control, and analysis software that allows users to create complex applications in minimal time without text-based programming. DASYLab is available as a purchased software download. Windows OS
MATLAB Driver		High-level language and interactive environment for numerical computation, visualization, and programming. The Data Acquisition Toolbox, provided by The Mathworks, allows users to acquire data from most MCC PCI and USB devices. Visit www.MathWorks.com for more information on MATLAB Data Acquisition Toolbox support.

USB-1608G Series

Specifications



Specifications

These specifications apply to both USB-1608G Series standard and OEM versions unless noted otherwise.

Analog Input

A/D Converter Type: Successive approximation

ADC Resolution: 16 bits

Number of Channels: 8 DIFF, 16 SE; software-selectable

Input Voltage Range: ± 10 V, ± 5 V, ± 2 V, ± 1 V; software-selectable per channel

Absolute Maximum Input Voltage

CHx Relative to AGND: ± 25 V max (power on); ± 15 V max (power off)

Input Impedance: 1 G Ω (power on); 820 Ω (power off)

Input Bias Current: ± 10 nA

Input Bandwidth

All Input Ranges, Small Signal (-3 dB)

USB-1608G: 750 kHz

USB-1608GX/1608GX-2AO: 870 kHz

Input Capacitance: 60 pf

Maximum Working Voltage (Signal + Common Mode)

± 10 V Range: ± 10.2 V max relative to AGND

± 5 V Range: ± 10.2 V max relative to AGND

± 2 V Range: ± 9.5 V max relative to AGND

± 1 V Range: ± 9.0 V max relative to AGND

Common Mode Rejection Ratio

$f_{IN} = 60$ Hz, All Input Ranges: 86 dB

Crosstalk

Adjacent Differential Mode Channels, DC to 100 kHz: -75 dB

Input Coupling: DC

Sampling Rate (Software-Selectable)

USB-1608G: 0.0149 Hz to 250 kHz

USB-1608GX/1608GX-2AO: 0.0149 Hz to 500 kHz

Trigger Source: TRIG (refer to "External Trigger" on page 5)

Sample Clock Source: Internal A/D clock or external A/D clock (AICKI terminal)

Burst Mode: Software-selectable using the internal A/D clock; always enabled when using the external clock (AICKI terminal)

USB-1608G: 4 μ s

USB-1608GX/1608GX-2AO: 2 μ s

Throughput

Software Paced: 33 to 4000 S/s typ, system dependent

Hardware Paced

USB-1608G: 250 ks/s max

USB-1608GX/1608GX-2AO: 500 ks/s max

Channel Gain Queue: Up to 16 elements; software-selectable range for each channel

Warm-up Time: 15 minutes min

Analog Input DC Voltage Measurement						
All Values are (\pm)						
Range	Gain Error (% of Reading)	Offset Error (μ V)	INL Error (% of Range)	Absolute Accuracy at Full Scale (μ V)	Gain Temperature Coefficient (% reading/ $^{\circ}$ C)	Offset Temperature Coefficient (μ V/ $^{\circ}$ C)
± 10 V	0.024	915	0.0076	4075	0.0014	47
± 5 V	0.024	686	0.0076	2266	0.0014	24
± 2 V	0.024	336	0.0076	968	0.0014	10
± 1 V	0.024	245	0.0076	561	0.0014	5

Noise Performance*		
Range	Counts	LSBrms
± 10 V	6	0.91
± 5 V	6	0.91
± 2 V	7	1.06
± 1 V	9	1.36

* For the peak-to-peak noise distribution test, a differential input channel is connected to AGND at the input terminal block, and 32,000 samples are acquired at the maximum rate available at each setting.

Settling Time**			
USB-1608G			
Range	4 μ S settling accuracy (% FSR)	6 μ S settling accuracy (% FSR)	10 μ S settling accuracy (% FSR)
± 10 V	0.0061	0.0031	0.0015
± 5 V	0.0061	0.0031	0.0015
± 2 V	0.0061	0.0031	0.0015
± 1 V	0.0061	0.0031	0.0015

Settling Time**			
USB-1608GX/1608GX-2AO			
Range	2 μ S settling accuracy (% FSR)	4 μ S settling accuracy (% FSR)	9 μ S settling accuracy (% FSR)
± 10 V	0.1251	0.0031	0.0015
± 5 V	0.0687	0.0031	0.0015
± 2 V	0.0687	0.0031	0.0015
± 1 V	0.0687	0.0031	0.0015

** Settling time is defined as the expected accuracy after one conversion when switching from a channel with a DC input at one extreme of full scale to another channel with a DC input at the other extreme of full scale. Both input channels are configured for the same input range.

Analog Output (USB-1608GX-2AO only)

Number of Channels: 2 (leave unused AOUTx output channels disconnected)

Resolution: 16 bits

Output Range: ± 10 V (calibrated)

Output Transient

Host computer is reset, powered on, suspended, or a reset command is issued to the device.

Duration: 500 μ s

Amplitude: 2 V pk-pk

Powered Off

Duration: 10 ms

Amplitude: 7 V peak

Differential Non-Linearity: ± 0.25 LSB typ; ± 1 LSB max

Output Current

AOUTx: ± 3.5 mA max

USB-1608G Series

Specifications



Output Short-Circuit Protection

AOUTx Connected to AGND: Unlimited duration

Output Coupling: DC

Power On and Reset State

DACs Cleared to Zero-Scale: 0 V, ± 50 mV (AOUTx defaults to 0 V whenever the host computer is reset, powered on, suspended, or a reset command is issued to the device)

Output Noise: 30 μ Vrms

Trigger Source: TRIG (refer to "External Trigger" on page 5)

Sample Clock Source: Internal D/A clock or external D/A clock (AOCKI terminal)

Output Update Rate: 500 kHz/number of channels in the scan

Settling Time

To Rated Accuracy, 10 V Step: 40 μ s

Slew Rate: 9 V/ μ s

Throughput

Software Paced: 33 S/s to 4000 S/s typ, system-dependent

Hardware Paced: 500 kS/s max, system-dependent

Calibrated Absolute Accuracy

Range: ± 10 V

Absolute Accuracy (\pm LSB): 16.0

Calibrated Absolute Accuracy Components

Range: ± 10 V

% of Reading: ± 0.0183

Offset (\pm mV): 1.831

Offset Tempco (μ V/ $^{\circ}$ C): 12.7

Gain Tempco (ppm of Range/ $^{\circ}$ C): 13

Analog Output Relative Accuracy

Range: ± 10 V

Relative Accuracy (INL): 4.0 typ

Analog Input/Output Calibration

Recommended Warm-Up Time: 15 minutes min

Calibration Method: Self-calibration (firmware)

Calibration Interval: 1 year (factory calibration)

AI Calibration Reference

+5 V, ± 2.5 mV max (actual measured values stored in EEPROM)

Tempco: 5 ppm/ $^{\circ}$ C max

Long Term Stability: 15 ppm/1000 hours

AOUTx Calibration Procedure (USB-1608GX-2AO only)

The AOUTx terminals are internally routed to the analog input circuit. For best calibration results, disconnect any AOUTx connections at the terminal block prior to performing AOUT calibration.

Digital I/O

Digital Type: CMOS

Number of I/O: 8

Configuration: Bit-configurable as input (power on default) or output

Pull-Up Configuration: The port has 47 k Ω resistors configurable as pull-ups or pull-downs (default) via internal jumper (W1).

Digital I/O Transfer Rate (System-Paced): 33 to 8000 port reads/writes or single bit reads/writes per second typ, system dependent.

Input High Voltage: 2.0 V min, 5.5 V absolute max

Input Low Voltage: 0.8 V max, -0.5 V absolute min, 0 V recommended min

Output High Voltage: 4.4 V min (IOH = -50 μ A), 3.76 V min (IOH = -2.5 mA)

Output Low Voltage: 0.1 V max (IOL = 50 μ A), 0.44 V max (IOL = 2.5 mA)

Output Current: ± 2.5 mA max

External Trigger

Trigger Source: TRIG input

Trigger Mode: Software configurable for edge or level sensitive, rising or falling edge, high or low level. Power on default is edge sensitive, rising edge.

Trigger Latency: 1 μ s + 1 clock cycle max

Trigger Pulse Width: 100 ns min

Input Type: Schmitt trigger, 33 Ω series resistor and 49.9 k Ω pull-down to ground

Schmitt Trigger Hysteresis: 0.4 V to 1.2 V

Input High Voltage: 2.2 V min, 5.5 V absolute max

Input Low Voltage: 1.5 V max, -0.5 V absolute min, 0 V recommended min

External Clock I/O

Terminal Names

AICKI, AICKO

USB-1608GX-2AO: AICKI, AICKO AOCKI, AOCKO

Terminal Types

AxCKI: Input, active on rising edge

AxCKO: Output, power on default is 0 V, active on rising edge

Terminal Descriptions

AxCKI: Receives sampling clock from external source

AxCKO: Outputs the internal sampling clock (D/A or A/D clock) or the pulse generated from AxCKI when in external clock mode.

Input Clock Rate

USB-1608G: 250 kHz max

USB-1608GX/1608GX-2AO: 500 kHz max

Clock Pulse Width

AxCKI: 400 ns min

AxCKO: 400 ns min

Input Type: Schmitt trigger, 33 Ω series resistor, 47 k Ω pull-down to ground

Schmitt Trigger Hysteresis: 0.4 V to 1.2 V

Input High Voltage: 2.2 V min, 5.5 V absolute max

Input Low Voltage: 1.5 V max, -0.5 V absolute min, 0 V recommended min

Output High Voltage: 4.4 V min (IOH = -50 μ A), 3.76 V min (IOH = -2.5 mA)

Output Low Voltage: 0.1 V max (IOL = 50 μ A), 0.44 V max (IOL = 2.5 mA)

Output Current: ± 2.5 mA max

Counter Input

Terminal Names: CTR0, CTR1

Number of Channels: 2 channels

Resolution: 32-bit

Counter Type: Event counter

Input Type: Schmitt trigger, 33 Ω series resistor, 47 k Ω pull-down to ground

Input Source:

CTR0 (terminal 52)

CTR1 (terminal 51)

Counter Read/Writes Rate (Software-Paced) : 33 to 8000 reads/writes per second typ, system dependent

Input High Voltage: 2.2 V min, 5.5 V max

Input Low Voltage: 1.5 V max, -0.5 V min

Schmitt Trigger Hysteresis: 0.4 V min, 1.2 V max

Input Frequency: 20 MHz, max

High Pulse Width: 25 ns, min

Low Pulse Width: 25 ns, min

Timer Output

Timer Terminal Name: TMR

Timer Type: PWM output with count, period, delay, and pulse width registers

Output Value: Default state is idle low with pulses high, software-selectable output invert

Internal Clock Frequency: 64 MHz

Register Widths: 32-bit

High Pulse Width: 15.625 ns min

Low Pulse Width: 15.625 ns min

Output High Voltage: 4.4 V min (IOH = -50 μ A), 3.76 V min (IOH = -2.5 mA)

Output Low Voltage: 0.1 V max (IOL = 50 μ A), 0.44 V max (IOL = 2.5 mA)

Output Current: ± 2.5 mA max

Memory

Data FIFO:

USB-1608G/1608GX: 4 kS analog input

USB-1608GX-2AO: 4 kS analog input, 2 kS analog output

Non-Volatile Memory: 32 KB (28 KB firmware storage, 4 KB calibration/user data)

USB-1608G Series

Ordering Information



Power

Supply Current

This is the total quiescent current requirement and includes up to 10 mA for the Status LED. This does not include any potential loading of the digital I/O bits, +5 V terminal, or the AOUTx outputs (USB-1608GX-2AO only).

Quiescent Current

USB-1608G/1608GX: 230 mA

USB-1608GX-2AO: 260 mA

+5 V User Output Voltage Range (Available at Terminal 43): 4.5 V min to 5.25 V max

+5 V User Output Current (Available at Terminal 43): 10 mA max

Environmental

Operating Temperature Range: 0 °C to 55 °C max

Storage Temperature Range: -40 °C to 85 °C max

Humidity: 0% to 90% non-condensing max

Mechanical

Signal I/O Connector

-OEM Models: Two 28-pin, 0.1 in. pitch headers

All Other Devices: 2 banks of screw-terminal blocks (wire gauge range 16 AWG to 30 AWG)

Dimensions (L × W × H):

Standard Version: 127 × 89.9 × 35.6 mm (5.00 × 3.53 × 1.40 in.)

OEM Version: 121.92 × 86.36 × 15.24 (4.80 × 3.40 × 0.60 in.)

Ordering Information

Part No.	Description
USB-1608G	16-channel, 250 kS/s device with two 32-bit counter inputs, one timer output, and eight DIO lines. Includes USB cable and MCC DAQ software CD.
USB-1608GX	16-channel, 500 kS/s device with two 32-bit counter inputs, one timer output, and eight DIO lines. Includes USB cable and MCC DAQ software CD.
USB-1608GX-2AO	16-channel, 500 kS/s device with two analog outputs, two 32-bit counter inputs, one timer output, and eight DIO lines. Includes USB cable and MCC DAQ software CD.
USB-1608G-OEM	Board-only USB-based DAQ device with 16-channels, 250 kS/s sampling, two 32-bit counter inputs, one timer output, and eight DIO lines.
USB-1608GX-OEM	Board-only USB-based DAQ device with 16-channel, 500 kS/s sampling, two 32-bit counter inputs, one timer output, and eight DIO lines.
USB-1608GX-2AO-OEM	Board-only USB-based DAQ device with 16-channels, 500 kS/s sampling, two analog outputs, two 32-bit counter inputs, one timer output, and eight DIO lines.

Software also Available from MCC

DAQami	Easy-to-use advanced data logging software to acquire, view, and log data
TracerDAQ Pro	Out-of-the-box virtual instrument suite with strip chart, oscilloscope, function generator, and rate generator – professional version
DASYLab	Icon-based data acquisition, graphics, control, and analysis software